

AVANT*well*

EQUIPMENTS



01. SUITE	3
02. BOX DELUXE	6
03. HALO	8
04. OFUROKNEIPP	10
05. BAÑO TURCO	17
06. SAUNA	19
07. TERMAL	21
08. MULTISENSORIAL	24
09. CAMILLAS MASAJE	25
10. CAMILLAS RELAX	26
11. CARRITOS	27
12. COMPLEMENTOS	28

AVANTwell

01 SUITE

Modelos Models	Suite Prestige Queen	Suite Prestige	Suite Prestige SPA	
Dimensiones Measures	* cm 448x308x246h. - 13,8mq-33mc	* cm 407x228x246h. - 9,28mq-22,8mc	* cm 407x228x246h. - 9,28mq-22,8mc	
Alimentación Power supply	400V trifase (triphase)+N+T @ 40 Ampère	400V trifase (triphase)+N+T @ 40 Ampère	400V trifase (triphase)+N+T @ 40 Ampère	
Absorción eléctrica Electrical absorption	18 kW/h	18 kW/h	12 kW/h	
Generador de vapor Steam generator	A presión Pressurized	A presión Pressurized	x	
Estufa Stove	Resistencia incandescente Incandescent resistance			
Alimentación de agua Water supply	Pared (altura 255 cm) de agua caliente y fría proveniente del agua de red doméstica Wall (255 cm height) water supply (hot/cold) from domestic water supply			
Drenaje de agua Water drainage	Sistema de drenaje de agua con balsa bajo el suelo Floor drainage system with catch basin			
Recirculación de Aire Air recirculation	2 tubos diam. 10 cm (in/out) 2 x 10 cm diam. pipes (in/out)	2 tubos diam. 10 cm (in/out) 2 x 10 cm diam. pipes (in/out)	2 tubos diam. 10 cm (in/out) 2 x 10 cm diam. pipes (in/out)	
Panel de Control y funciones Control panel and functions	PC con touch-screen, >25 programas pre-instalados, 2 programas stand-by (seco/húmedo), 1 programa personalizable Touch-screen PC, >25 preset programs, 2 stand-by programs (dry/wet), 1 customizable program	PC con touch-screen, >25 programas pre-instalados, 2 programas stand-by (seco/húmedo), 1 programa personalizable Touch-screen PC, >25 preset programs, 2 stand-by programs (dry/wet), 1 customizable program	preinstalados, 2 progra.personalizables, 1 progra. stand-by seco, 1 programa precalentamiento Touch-screen with 6 preset programs, 2 customizable programs, 1 stand-by program (dry), 1 pre-heating program	
Controles internos Internal controls	Ducha Vichy con salida automática, selector doble de cromoterapia, pulsador de llamada a operador, pulsador para llamada de emergencia Vichy shower with automatic slide, double chromotherapy switch, operator call button, emergency stop	Ducha Vichy con salida automática, selector doble de cromoterapia, pulsador de llamada a operador, pulsador para llamada de emergencia Vichy shower with automatic slide, double chromotherapy switch, operator call button, emergency stop	Doble selector para cromoterapia, pulsador de llamada a operador, pulsador para llamada de emergencia Double chromotherapy switch, operator call button, emergency stop	
Características internas Internal features	Cromoterapia en techo/paredes, 2 camillas de savonage, ducha vichy, ducha tropical, calentador de fango con termostato, bancos plegables Ceiling/wall chromotherapy, 2 savonage beds, vichy shower, tropical shower, mud heater with thermostat, foldable benches	Cromoterapia en techo/paredes, 1 camilla de savonage, ducha vichy, ducha tropical, calentador de fango con termostato, bancos plegables Ceiling/wall chromotherapy, 1 savonage bed, vichy shower, tropical shower, mud heater with thermostat, foldable benches	Cromoterapia en techo/paredes, ducha tropical, calentador de fango con termostato Ceiling/wall chromotherapy, tropical shower, mud heater with thermostat	

T
E
C
H
N
I
C
A

D
A
T
A

S
H
E
E
T

/
F
I
C
H
A

T
E
C
N
I
C
A

AVANTwell

01. 1 SUITE PRESTIGE QUEEN



cm 448x308x246h. -13,8mq -33mc

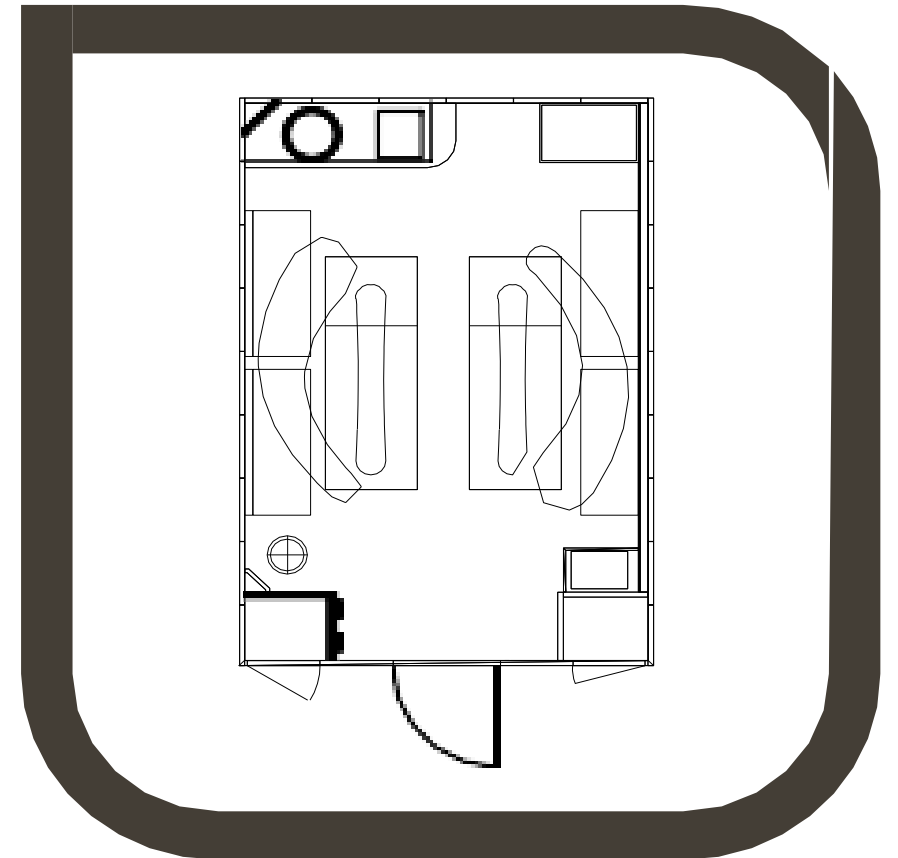

* Altura mínima necesaria para efectuar la instalación: cm 270 | * 270 cm is the minimum ceiling height for the installation

La tecnología y accesorios descrito son indicativos y pueden ser modificado sin aviso previo por AVANTwell, en diseño, especificaciones técnicas, características y colores | Technologies and accessories described in this brochure are indicative and can be modified without notice from AVANTwell in design, technical specifications, features and colours.

AVANTwell

01.2 SUITE PRESTIGE

cm 407x228x246h. -9,28mq-22,8mc

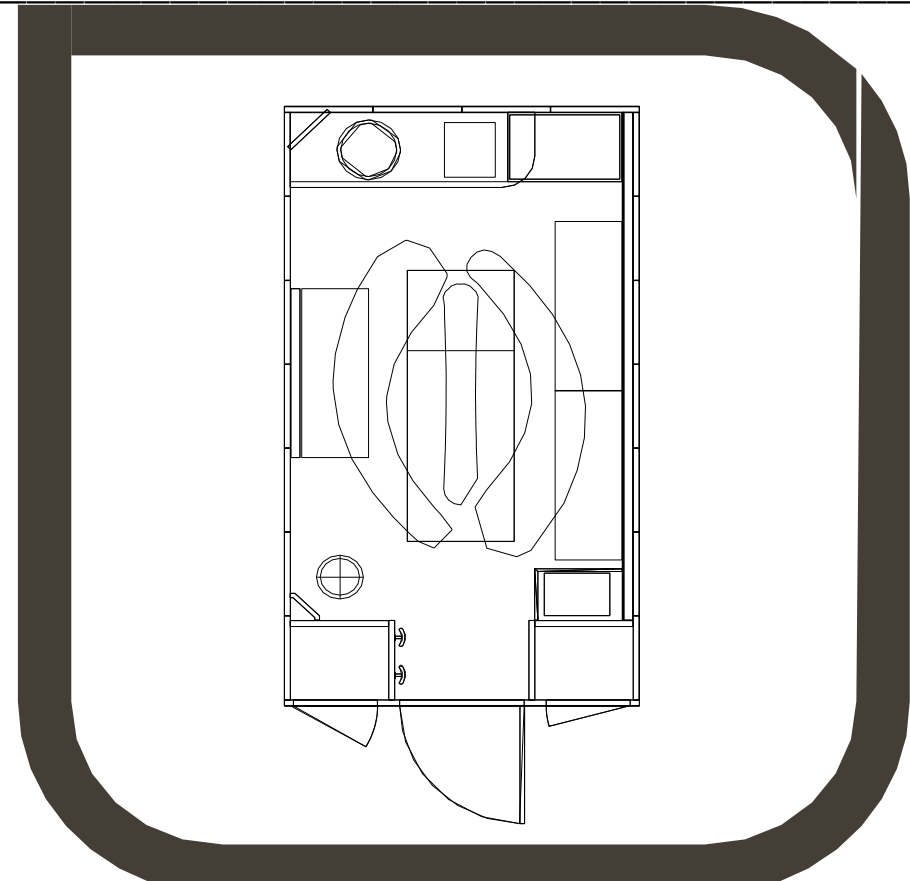

* Altura mínima necesaria para efectuar la instalación: cm 270 | * 270 cm is the minimum ceiling height for the installation

La tecnología y accesorios descrito son indicativos y pueden ser modificado sin aviso previo por AVANTwell, en diseño, especificaciones técnicas, características y colores | Technologies and accesories described in this brochure are indicative and can be modified without notice from AVANTwell in design, technical specifications, features and colours.

AVANTwell

01.3 SUITE PRESTIGE SPA

cm 407x228x246h. -9,28mq-22,8mc

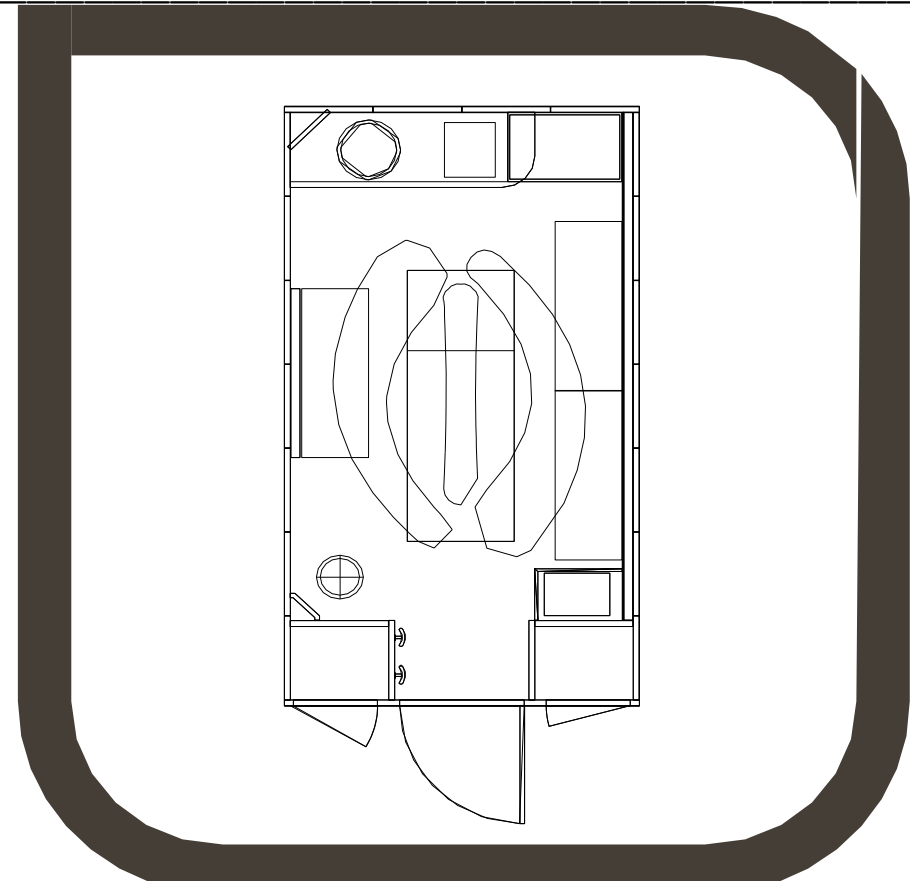

* Altura mínima necesaria para efectuar la instalación: cm 270 | * 270 cm is the minimum ceiling height for the installation

La tecnología y accesorios descrito son indicativos y pueden ser modificado sin aviso previo por AVANTwell, en diseño, especificaciones técnicas, características y colores | Technologies and accessories described in this brochure are indicative and can be modified without notice from AVANTwell in design, technical specifications, features and colours.

AVANTwell

02 BOX DELUXE

Modelos <i>Models</i>	BOX DELUXE PRESTIGE	BOX DELUXE SPA
Dimensiones <i>Measures</i>	cm 100x240x95h. (h. 210 cm abierta <i>open</i>) - 180 kg	cm 90x226x95h. (h. 210 cm abierta <i>open</i>) - 180 kg
Alimentación <i>Power supply</i>	220V trifase (<i>triphase</i>)+N+T @ 16 Ampère	220V trifase (<i>triphase</i>)+N+T @ 16 Ampère
Absorción eléctrica <i>Electrical absorption</i>	3,5 kW/h	2,6 kW/h
Generador de vapor <i>Steam generator</i>	A presión <i>Pressurized</i>	
Alimentación de agua <i>Water supply</i>	Pared de agua caliente y fría proveniente del agua de red doméstica <i>Floor water supply (hot/cold) from domestic water supply</i>	
Drenaje del Agua <i>Water drainage</i>	Sistema de drenaje de agua con balsa bajo el suelo <i>Floor drainage system with catch basin</i>	
Panel de Control y funciones <i>Control panel and functions</i>	Touch-screen con 18 programas preinstalados, y programas personalizables <i>Touch-screen with 18 preset programs, 2 customizable programs</i>	
Controles internos <i>Internal controls</i>	Pulsador on/off para sistema de nebulización de agua, tubo de ducha flexible, pulsador de llamada a operador, pulsador de emergencia <i>On/off button for water nebulization system, flexible shower tube, operator call button, emergency stop</i>	
Controles externos <i>External controls</i>	Mezclador de agua <i>Water mixer</i>	
Características internas <i>Internal features</i>	Manguera estirable para ducha, cromoterapia con selector de 3 programas pre-instalados, sistema de nebulización de agua, (nebulizador salino) <i>Flexible shower tube, chromotherapy switch with 3 preset programs, water nebulization system, (salt nebulizer)</i>	Manguera/Ducha flexible, cromoterapia con selector de 3 programas pre-instalados, sistema de nebulización de agua, (nebulizador salino) <i>Flexible shower tube, chromotherapy switch with 3 preset programs, water nebulization system, (salt nebulizer)</i>
Características externas <i>External features</i>	Cojín ergonómico de silicona <i>Ergonomic silicone pillow</i>	Cojín ergonómico de silicona <i>Ergonomic silicone pillow</i>

T
E
C
H
N
I
C
A

D
A
T
A

S
H
E
E
T

/

F
I
C
H
A

T
E
C
N
I
C
A

AVANTwell

02.1 BOX DELUXE PRESTIGE



cm 100x240x95h. (h. 210 cm Abierto | open) 180kg

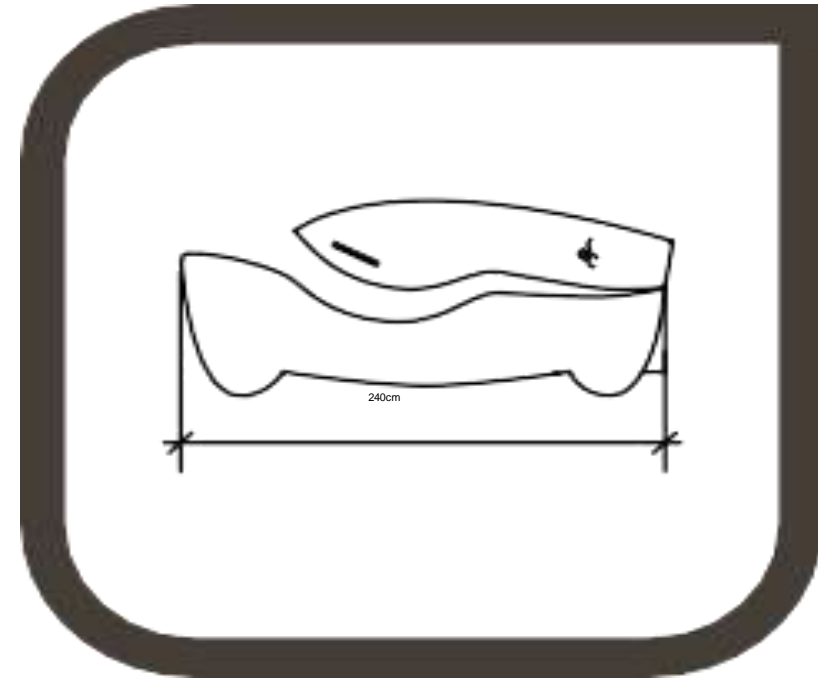

La tecnología y accesorios descrito son indicativos y pueden ser modificado sin aviso previo por AVANTwell, en diseño, especificaciones técnicas, características y colores | *Technologies and accesories described in this brochure are indicative and can be modified without notice from AVANTwell in design, technical specifications, features and colours.*

AVANTwell

02.2 BOX DELUXE SPA



cm 90x226x95h. (h. 210 cm Abierto | open) 180kg

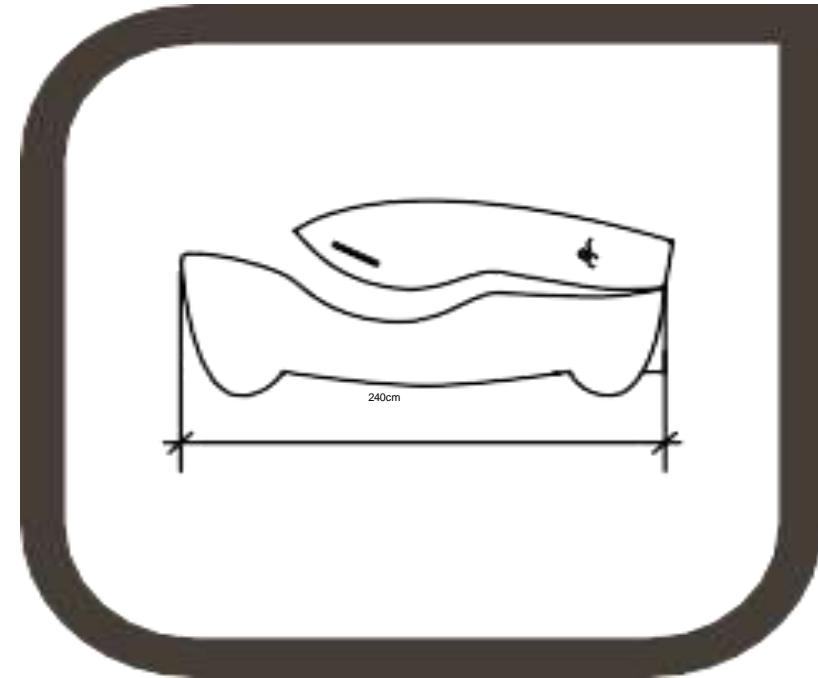

La tecnología y accesorios descrito son indicativos y pueden ser modificado sin aviso previo por AVANTwell, en diseño, especificaciones técnicas, características y colores | *Technologies and accesories described in this brochure are indicative and can be modified without notice from AVANTwell in design, technical specifications, features and colours.*

T
E
C
H
N
I
C
A

D
A
T
A

S
H
E
E
T

/

F
I
C
H
A

T
E
C
N
I
C
A

AVANTwell

03 HALO

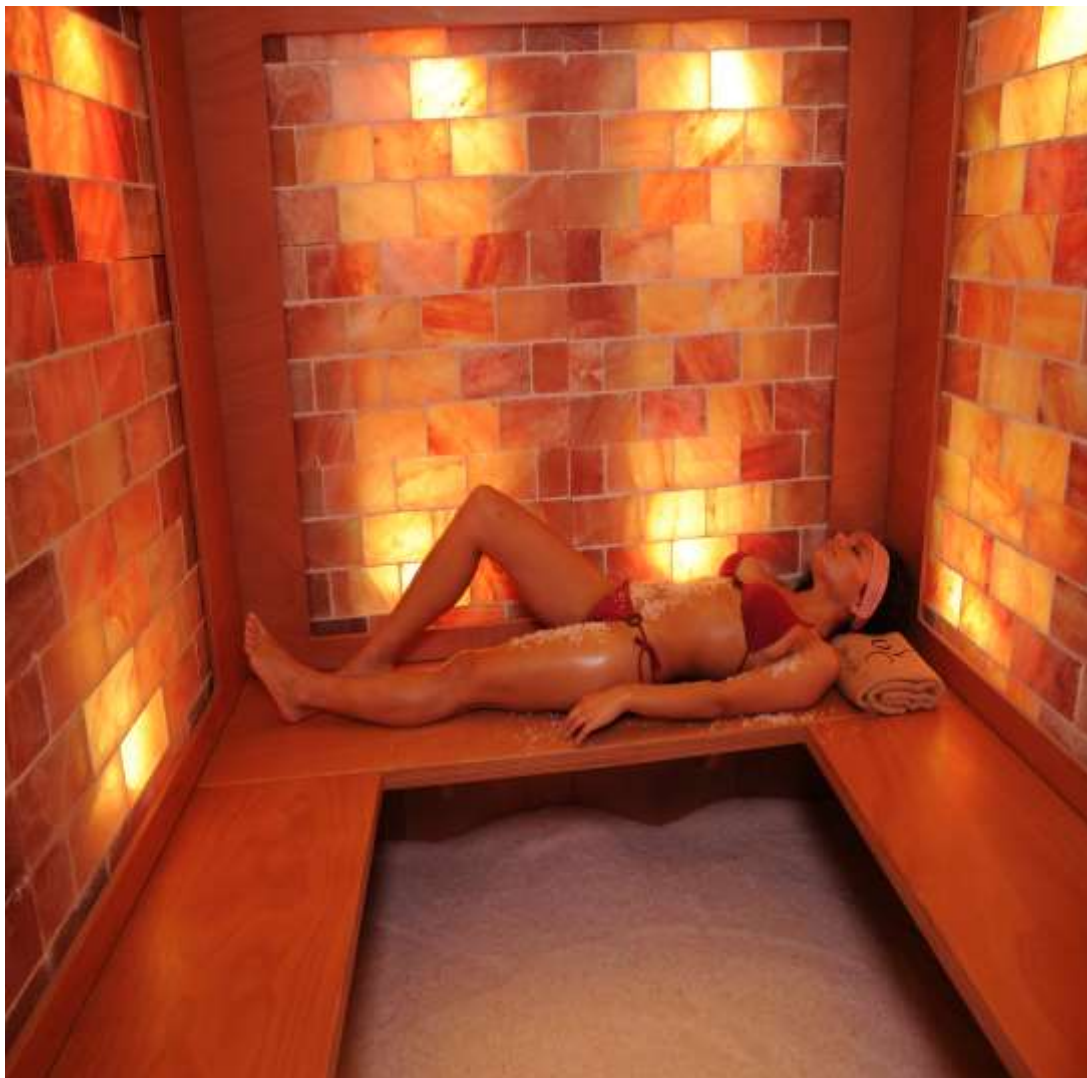

Modelos Models	Halo Prestige Queen	Halo Prestige
Dimensiones Measures	cm 448x308x246h. - 13,8mq-33mc	cm 407x228x246h. - 9,28mq-22,8mc
Alimentación Power supply	400V trifase (triphase)+N+T @ 40 Ampère	
Absorción eléctrica Electrical absorption	11 kW/h	8 kW/h
Generador de vapor Steam generator	x	x
Calentador Stove	Resistencia incandescente Incandescent resistance	
Alimentación de agua Water supply	x	x
Drenaje del Agua Water drainage	x	x
Recirculación aire Air recirculation	1 tubo diam. 10 cm (salida) 1 x 10 cm diam. pipe (out)	
Panel de Control y funciones Control panel and functions	Selector de temperatura de la biosauna, control (nebulizador salino) y control de la iluminación interna Stove temperature control, (salt nebulizer) and light switch	
Controles internos Internal controls	Pulsador de llamada a operador, pulsador para llamada de emergencia Operator call button, emergency stop	
Características internas Internal features	Cromoterapia en techo y paredes, bancos fijos Ceiling/wall chromotherapy, benches	
Características externas External features	HI-FI con lector CD/MP3, port USB HI-FI with CD/MP3 player, USB port	
Opcional si requerido Optionals upon request	x	x

T
E
C
H
N
I
C
A

D
A
T
A

S
H
E
E
T

/
F
I
C
H
A

T
E
C
N
I
C
A

03.1 HALO PRESTIGE QUEEN



cm 448x308x246h. - 13,8mq-33mc

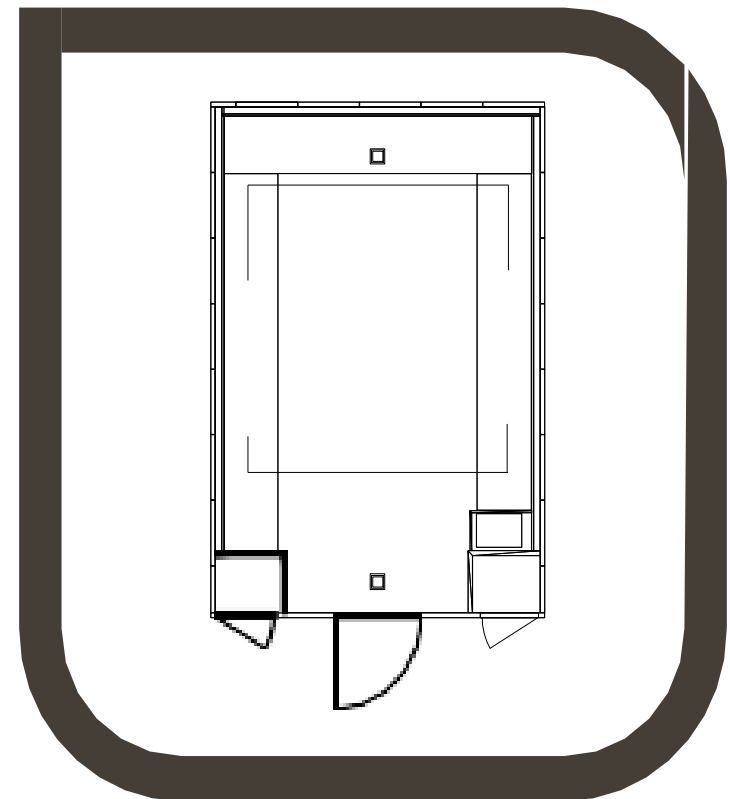

* Altura mínima del local necesaria para efectuar la instalación: cm 270 |
* 270 cm is the minimum ceiling height for the installation

La tecnología y accesorios descrito son indicativos y pueden ser modificado sin aviso previo por AVANTwell, en diseño, especificaciones técnicas, características y colores | Technologies and accesories described in this brochure are indicative and can be modified without notice from AVANTwell in design, technical specifications, features and

T
E
C
H
N
I
C
A

D
A
T
A

S
H
E
E
T

/

F
I
C
H
A

T
E
C
N
I
C
A

AVANTwell

03.2 HALO PRESTIGE



cm 407x228x246h. - 9,28mq-22,8mc

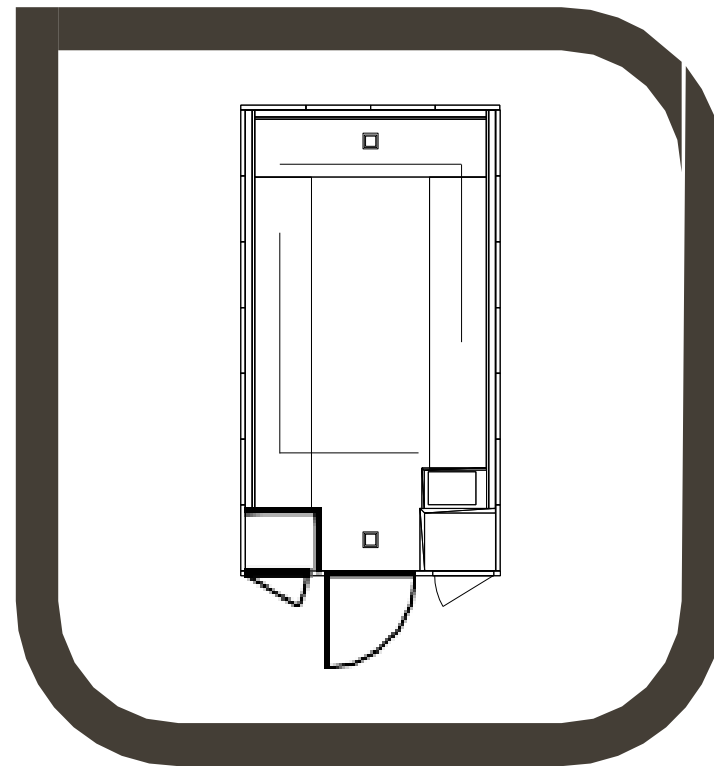

* Altura mínima del local necesaria para efectuar la instalación: cm 270 | * 270 cm is the minimum ceiling height for the installation

La tecnología y accesorios descrito son indicativos y pueden ser modificado sin aviso previo por AVANTwell, en diseño, especificaciones técnicas, características y colores | Technologies and accesories described in this brochure are indicative and can be modified without notice from AVANTwell in design, technical specifications, features and colours.

AVANTwell

04 OFUROKNEIPP

Modelos Models	OfuroKneipp	Hydrofuro	Ofuro Tina
Dimensiones Measures	cm 330x400x110h. (h. 260 cm skyline) - 600 kg/mq	cm 180x187x110h. (cm 260 con escalera including stairs) - 600 kg/mq	cm 140x140x110h. (cm 220 con escalera including stairs) - 500 kg/mq
Alimentación Power supply	400V pentapolare (pentapolar) @ 32 Ampère	400V trifase (triphase) @ 32 Ampère	220V (standard)
Absorción eléctrica Electrical absorption	7,5 kW/h	7,5 kW/h	Max 1 kW/h
Alimentación de agua Water supply	Pared de agua caliente y fría proveniente del agua de red doméstica Wall water supply (hot/cold) from domestic water supply		
Drenaje del Agua Water drainage	Sistema de drenaje de agua con balsa bajo el suelo Floor drainage system with catch basin	Touch-screen con programas pre-instalados y programa manual Touch-screen with preset programs and manual program	
Panel de Control y funciones Control panel and functions	Touch-screen con programas preinstalados, y programas manuales Touch-screen with preset programs and manual program	Pulsador parada emergencia Emergency stop	Mezclador de agua Water mixer
Controles externos External controls	Pulsador de emergencia Emergency stop	Cromoterapia subacuática, ozonoterapia con oxígeno líquido, hidromasaje Underwater chromotherapy, ozone-therapy with liquid oxygen, whirlpool	Cromoterapia subacuática Underwater chromotherapy
Características internas Internal features	Cromoterapia subacuática, ozonoterapia con oxígeno líquido, hidromasaje Underwater chromotherapy, ozone-therapy with liquid oxygen, whirlpool	Minipiscina caliente, luces en skyline, desinfección con bromo, sistema de filtración con arena, mezclador de agua con manguera extensible Hot mini-pool, Skyline lights, bromine hygienization system, sand filtration system, water mixer with extensible shower tube	Mezclador de agua con manguera extensible Water mixer with extensible shower tube
Características externas External features	Mini-piscina caliente + mini-piscina fría, flexo azul perimetral, skyline iluminado, sistema de desinfección en base a bromo y sistema de filtración de arena Hot mini-pool + cold mini-pool, perimetral blue flexoled, skyline lights, bromine hygienization system, sand filtration system	Flexo azul perimetral Perimetral blue flexolea	Sistema de oxigenoterapia con oxígeno líquido, pasamanos lateral Ozone-therapy with liquid oxygen system, handrail
Opcional si requerido Optionals upon request	x		

T
E
C
H
N
I
C
A

D
A
T
A

S
H
E
E
T

/

F
I
C
H
A

T
E
C
N
I
C
A

AVANTwell

04.1 OFUROKNEIPP



cm 330x400x110h. (h. 260 cm skyline) – 600 kg / mq

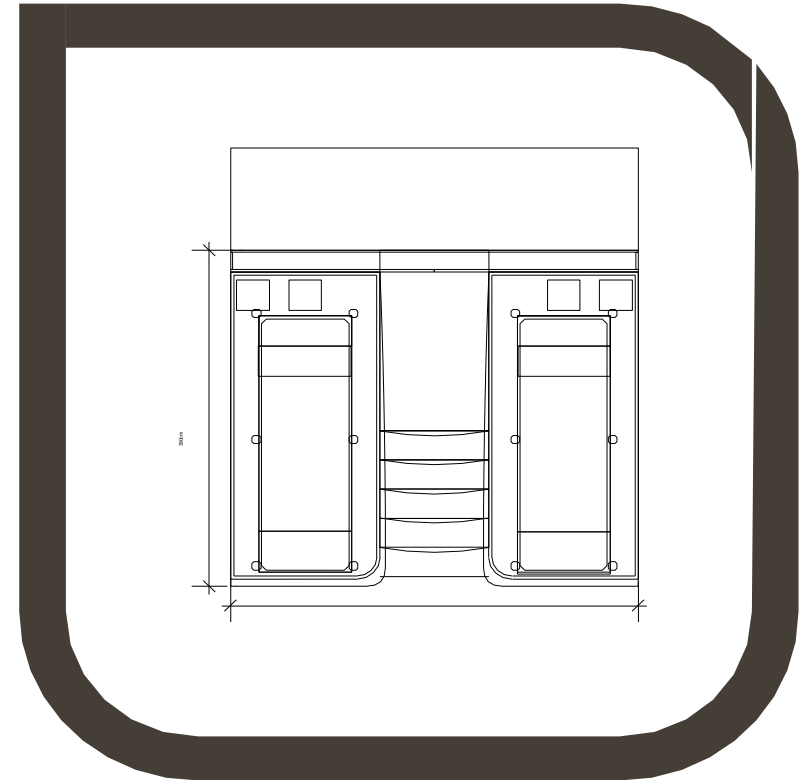

* Altura mínima del local necesaria para efectuar la instalación:cm 270
| * 270 cm is the minimum ceiling height for the installation

La tecnología y accesorios descrito son indicativos y pueden ser modificado sin aviso previo por AVANTwell, en diseño, especificaciones técnicas, características y colores | Technologies and accesories described in this brochure are indicative and can be modified without notice from AVANTwell in design, technical specifications, features and

AVANTwell

04.2 HYDROFURO

cm 180x187x110h.(cm 260 con escalera /including stairs)600 kg/mq

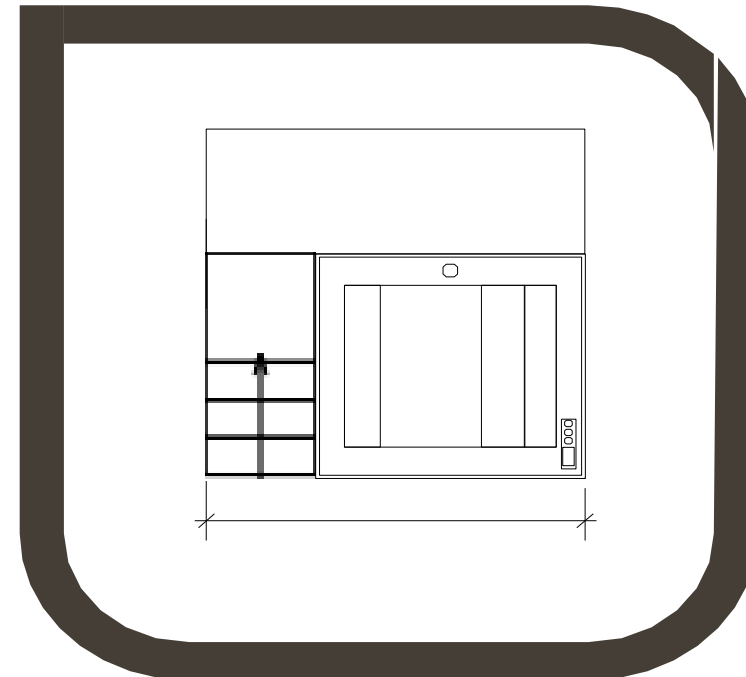

* Altura mínima del local necesaria para efectuar la instalación: cm 270 | * 270 cm is the minimum ceiling height for the installation

La tecnología y accesorios descrito son indicativos y pueden ser modificado sin aviso previo por AVANTwell, en diseño, especificaciones técnicas, características y colores | Technologies and accesories described in this brochure are indicative and can be modified without notice from AVANTwell in design, technical specifications, features and

AVANTwell

04.3 OFURO TINA



cm 140x140x110h.(cm 220 con escalera /including stairs) 500 kg/mq

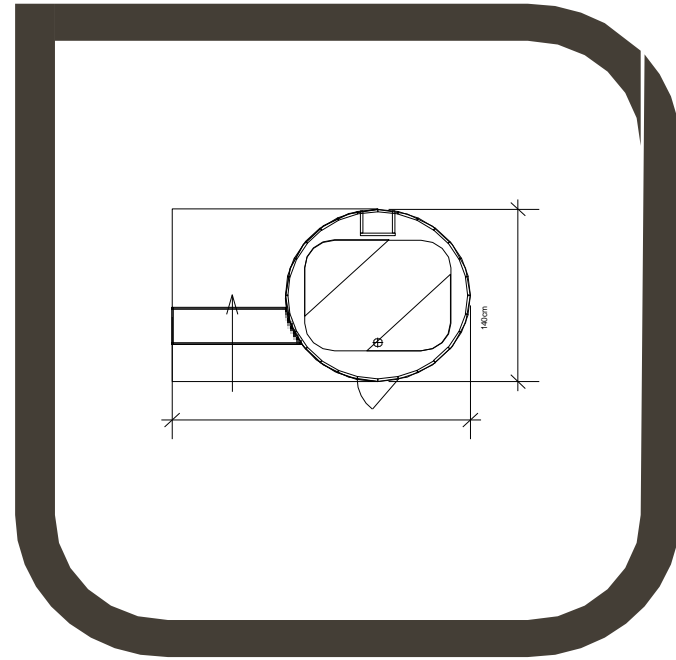

* Altura mínima del local necesaria para efectuar la instalación: cm 270 | * 270 cm is the minimum ceiling height for the installation

La tecnología y accesorios descrito son indicativos y pueden ser modificado sin aviso previo por AVANTwell, en diseño, especificaciones técnicas, características y colores | Technologies and accesories described in this brochure are indicative and can be modified without notice from AVANTwell in design, technical specifications, features and

AVANTwell

05 BAÑO TURCO

Modelos <i>Models</i>	Baño Turco Queen	Baño Turco Prestige	Baño Turco Spa
Dimensiones <i>Measures</i>	cm 448x308x246h. - 13,8mq-33mc	cm 407x228x246h. - 9,28mq-22,8mc	cm 236x228x246h. - 5,38mq-14,27mc
Alimentación <i>Power supply</i>	400V trifase (<i>triphase</i>)+N+T @ 40 Ampère	400V trifase (<i>triphase</i>)+N+T @ 40 Ampère	400V trifase (<i>triphase</i>)+N+T @ 40 Ampère
Absorción eléctrica <i>Electrical absorption</i>	18 kW/h	12 kW/h	7 kW/h
Generador de vapor <i>Steam generator</i>	A presión <i>Pressurized</i>		
Calentador <i>Stove</i>	Resistencia incandescente <i>Incandescent resistance</i>		
Alimentación de agua <i>Water supply</i>	X	X	X
Drenaje de agua <i>Water drainage</i>	X	X	X
Recirculación de aire <i>Air recirculation</i>	X	X	X
Panel de Control y funciones <i>Control panel and functions</i>	Control de temperatura del calentador y de las luces internas, control manual para la generación de vapor <i>Stove temperature control and light switch, manual control for the steam generator</i>		
Controles internos <i>Internal controls</i>	Pulsador de llamada a operador, pulsador para llamada de emergencia <i>Operator call button, emergency stop</i>		
Opcional interno <i>Internal optional</i>	Cromoterapia en el techo, bancos <i>Ceiling chromotherapy, benches</i>		
Características externas <i>External features</i>	HI-FI con lector CD/MP3, port USB <i>Hi-Fi with CD/MP3 player, USB port</i>		
Opcional si requerido <i>Optionals upon request</i>	X	X	X
Opcionales extra <i>Special optional</i>	Ingreso lateral, camilla masaje <i>Side entrance, massage bea</i>	Ingreso lateral, camilla masaje <i>Side entrance, massage bea</i>	X

* Altura mínima necesaria para efectuar la instalación: cm 270 | * 270 cm is the minimum ceiling height for the installation

La tecnología y accesorios descrito son indicativos y pueden ser modificado sin aviso previo por AVANTwell, en diseño, especificaciones técnicas, características y colores | *Technologies and accesories described in this brochure are indicative and can be modified without notice from AVANTwell in design, technical specifications, features and colours.*

AVANTwell

05 BAÑO TURCO



Baño Turco Queen 05.1

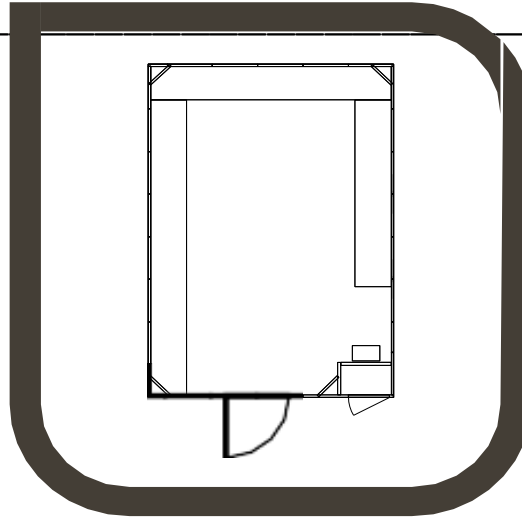

cm 448x308x246h. - 13,8mq-33mc

Baño Turco Prestige 05.2

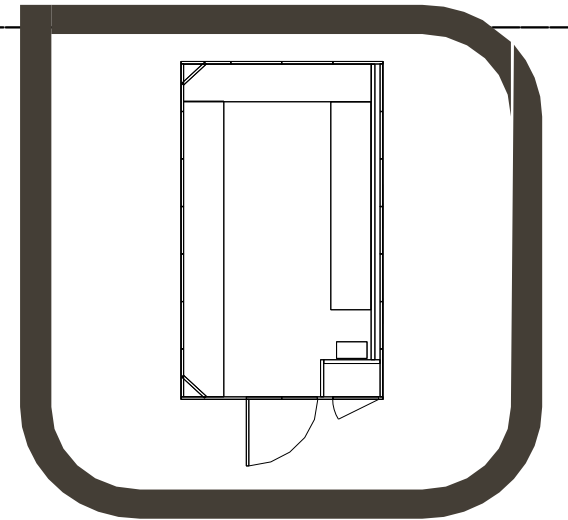

cm 407x228x246h. - 9,28mq-22,8mc

Baño Turco Spa 05.3

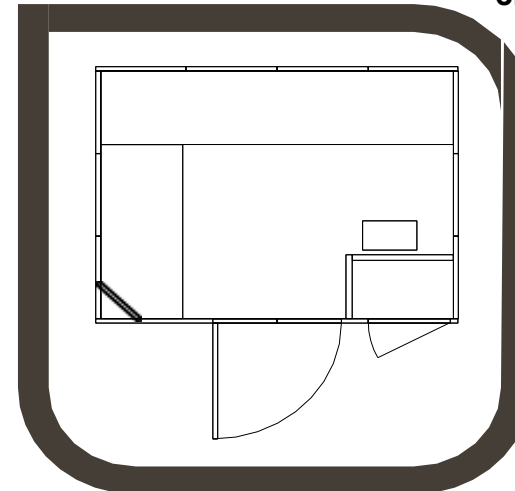

cm 236x228x246h. - 5,38mq-14,27mc

AVANTwell

06 SAUNA

Modelos <i>Models</i>	Sauna Queen	Sauna Prestige	Sauna Spa
Dimensiones <i>Measures</i>	cm 448x308x246h. - 13,8mq-33mc	cm 407x228x246h. - 9,28mq-22,8mc	cm 236x228x246h. - 5,38mq-14,27mc
Alimentación <i>Power supply</i>	400V trifase (<i>triphase</i>)+N+T @ 40 Ampère	400V trifase (<i>triphase</i>)+N+T @ 40 Ampère	400V trifase (<i>triphase</i>)+N+T @ 40 Ampère
Absorción eléctrica <i>Electrical absorption</i>	12 kW/h	12 kW/h	10 kW/h
Generador de vapor <i>Steam generator</i>	x	x	x
Calentador <i>Stove</i>	Resistencia incandescente <i>Incandescent resistance</i>		
Alimentación de agua <i>Water supply</i>	x	x	x
Drenaje de agua <i>Water drainage</i>	x	x	x
Recirculación de aire <i>Air recirculation</i>	x	x	x
Panel de Control y funciones <i>Control panel and functions</i>	Control de temperatura y de las luces internas <i>Stove temperature control and light switch</i>		
Controles internos <i>Internal controls</i>	Pulsador de llamada a operador, pulsador para llamada de emergencia <i>Operator call button, emergency stop</i>		
Características internas <i>Internal features</i>	Cromoterapia en el techo, bancos <i>Ceiling chromotherapy, benches</i>		
Características externas <i>External features</i>	HI-FI con lector CD/MP3, port USB <i>Hi-Fi with CD/MP3 player, USB port</i>		
Opcional si requerido <i>Optionals upon request</i>	x	x	x
Opcionales extra <i>Special optionals</i>	Entrada lateral, camilla para masaje <i>Side entrance, massage bed</i>	Ingreso lateral, camilla para masaje <i>Side entrance, massage bed</i>	x

* Altura mínima necesaria para efectuar la instalación: cm 270 | * 270 cm is the minimum ceiling height for the installation

La tecnología y accesorios descrito son indicativos y pueden ser modificado sin aviso previo por AVANTwell, en diseño, especificaciones técnicas, características y colores | *Technologies and accessories described in this brochure are indicative and can be modified without notice from AVANTwell in design, technical specifications, features and colours.*

T
E
C
H
N
I
C
A

D
A
T
A

S
H
E
E
T

/

F
I
C
H
A

T
E
C
N
I
C
A

06 BAÑO TURCO Sauna Queen 06.1

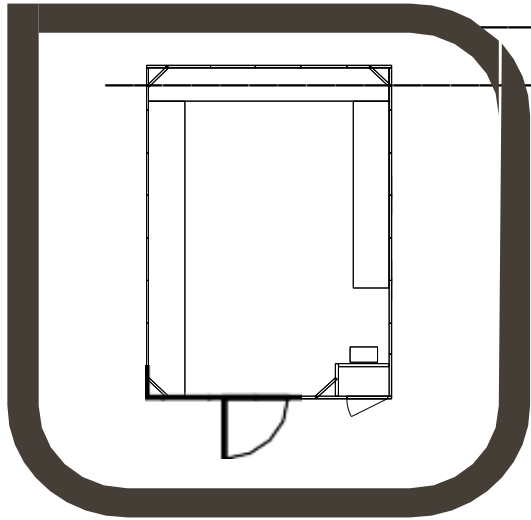

cm 448x308x246h. - 13,8mq-33mc



Sauna Prestige 06.2

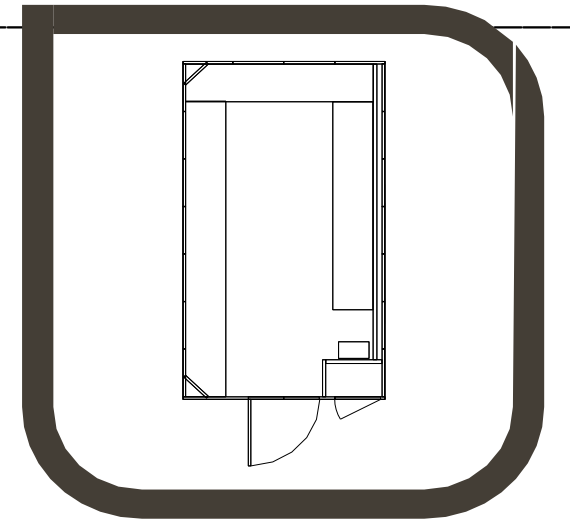

cm 407x228x246h. - 9,28mq-22,8mc

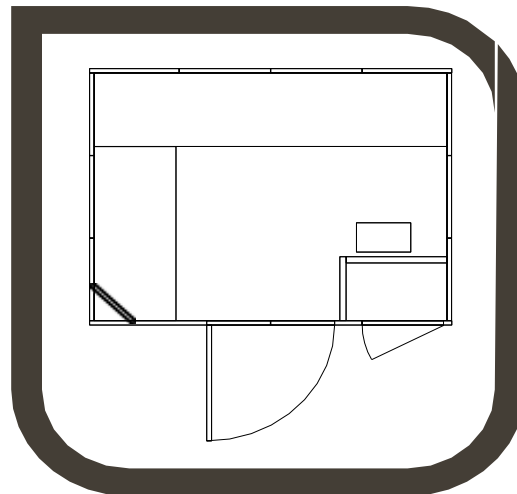

Sauna Spa 06.3 cm 236x228x246h. - 5,38mq-14,27mc

AVANTwell

07 THERMAL



Modelos <i>Models</i>	Thermal Deluxe	Thermal Spa
Dimensiones y Peso <i>Measures and Weight</i>	cm 220x81x85h.- 110 kg	cm 220x81x85h.- 110 kg
Alimentación <i>Power supply</i>	220V	220V
Absorción eléctrica <i>Electrical absorption</i>	2 kW/h	2 kW/h
Generador de vapor <i>Steam generator</i>	A presión <i>Pressurized</i>	A presión <i>Pressurized</i>
Alimentación de agua <i>Water supply</i>	Flujo de agua en el suelo (caliente y fría) proveniente del agua de red doméstica <i>Floor water supply (hot/cold) from domestic water supply</i>	
Drenaje de agua <i>Water drainage</i>	Sistema de drenaje a través del suelo <i>Floor drainage system</i>	
Controles internos <i>Internal controls</i>	Manguera de ducha flexible <i>Flexible shower tube</i>	
Controles externos <i>External controls</i>	Mezclador de agua <i>Water mixer</i>	
Características internas <i>Internal features</i>	Ducha flexible, cromoterapia <i>Flexible shower tube, chromotherapy</i>	Ducha flexible, cromoterapia, (nebulizador salino) <i>Flexible shower tube, chromotherapy, (salt nebulizer)</i>
Características externas <i>External features</i>	Arquetas y colchones extraíbles <i>Removable bows, removable mattress</i>	

T
E
C
H
N
I
C
A

D
A
T
A

S
H
E
E
T

/

F
I
C
H
A

T
E
C
N
I
C
A

AVANTwell

07.1 THERMAL DELUXE

cm 220x81x85h.- 110 kg

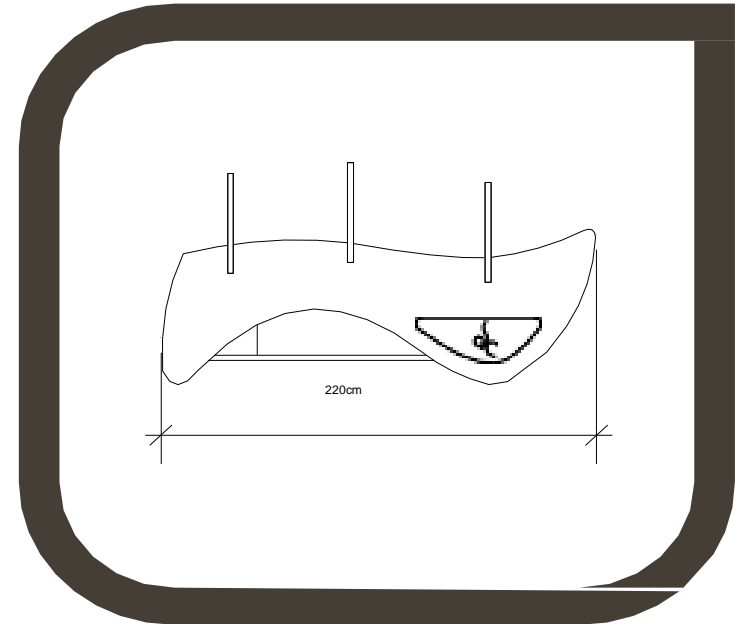

T
E
C
H
N
I
C
A

D
A
T
A

S
H
E
E
T

/

F
I
C
H
A

T
E
C
N
I
C
A

La tecnología y accesorios descrito son indicativos y pueden ser modificado sin aviso previo por AVANTwell, en diseño, especificaciones técnicas, características y colores | Technologies and accessories described in this brochure are indicative and can be modified without notice from AVANTwell in design, technical specifications, features and colours

AVANTwell

07.2 THERMAL SPA

cm 220x81x85h.- 110 kg

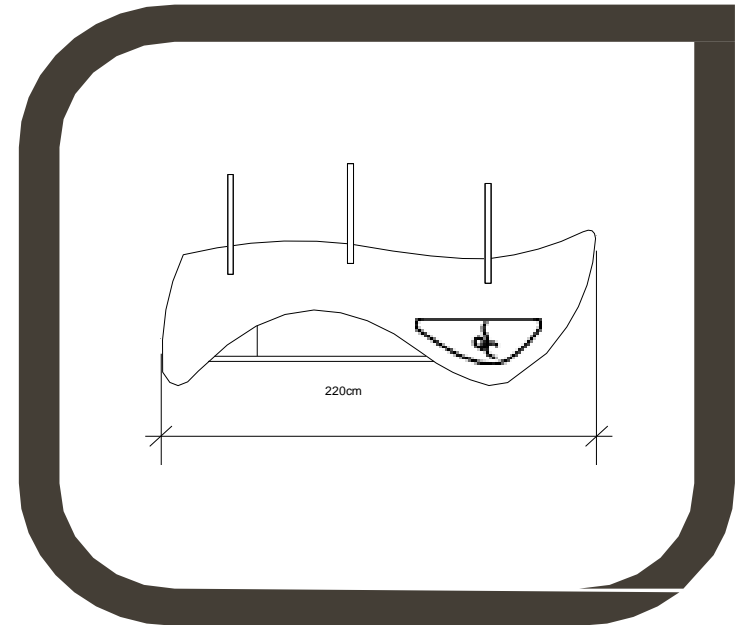

T
E
C
H
N
I
C
A

D
A
T
A

S
H
E
E
T

/





F
I
C
H
A

T
E
C
N
I
C
A

La tecnología y accesorios descrito son indicativos y pueden ser modificado sin aviso previo por AVANTwell, en diseño, especificaciones técnicas, características y colores | Technologies and accessories described in this brochure are indicative and can be modified without notice from AVANTwell in design, technical specifications, features and colours

AVANTwell

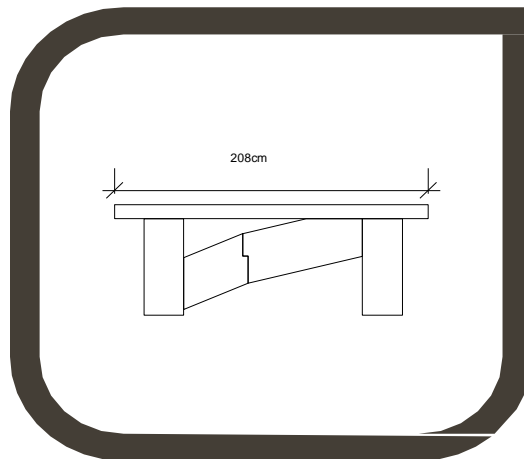

08 MULTISENSORIAL

Modelo Models	Multisensorial	Multisensorial Halo		
Dimensiones Measures	cm 208x88x80h.	cm 208x88x80h.		
Alimentación Power supply	220V	220V		
Asorción eléctrica Electrical absorption	2 kW/h	2 kW/h		
Calentador Heater	Panel eléctrico radiante Radiant electric panel			
Panel de control y funciones Control panel and functions	Selector con 4 temperaturas preseleccionadas, comando ciclo cromoterapia 4 preset temperature control, chromotherapy control			
Opciones internas Internal options	Led de Cromoterapia,colchón de agua Led chromotherapy, water mattress			
Acabados disponibles/ Available finishings	 okumè	 wengé	 okumè	 wengé



T E C H N I C A D A T A S H E E T / F I C H A T E C N I C A

09 CAMILLA MASAJE

Modelos Models		RUBI	
Dimensiones y Peso Measures and Weight		cm 188x72x80h. - 52 kg	
Material Material		Madera Okumé / Massive okumé wood	
Características Features		Colchón de semipiel blanco, portarollos, orificio para la cara con cojín extraíble, superficie de apoyo inferior, respaldo ajustable <i>White synthetic leather mattress, paper roll holder, removable face cradle, lower shelf, adjustable backrest</i>	
Opciones especiales Special options		X	
Acabados disponibles / Available finishings		 okumè	 wengé







Modelos Models		AYURVEDA	
Dimensiones y Peso Measures and Weight		cm 188x72x76h. - 35 kg	
Material Material		Madera Okumé / Massive okumé wood	
Características Features		Colchón de semipiel blanco, portarollos, orificio para la cara con cojín extraíble, superficie de apoyo inferior, respaldo ajustable <i>White synthetic leather mattress, paper roll holder, removable face cradle, lower shelf, adjustable backrest</i>	
Opciones especiales Special options		X	
Acabados disponibles / Available finishings		 okumè	



AVANTwell

10 CAMILLAS RELAX

Modelos <i>Models</i>	RELAX DELUXE	RELAX SPA
Dimensiones y Peso Measures and Weight	cm 220x75x33h. - 32 kg	cm 168x60x80h. - 21 kg
Material <i>Material</i>	Madera Okumè / <i>Massive okumè wood</i>	Madera Okumè / <i>Massive okumè wood</i>
Características <i>Features</i>	Colchón acolchado de puro algodón, respaldo regulable, asiento ultraconfortable <i>Heavy stuffed pure cotton mattress, adjustable backrest, ultra-comfortable pillow</i>	Forma ergonómica, listones de madera maciza <i>Ergonomic shape, massive wood slats</i>
Opciones especiales <i>Special options</i>	X	Colchón acolchado y desenfundable de puro algodón <i>Removable heavy stuffed pure cotton mattress</i>
Acabados disponibles / Available finishings	 okumè  wengé	 okumè  wengé



T
E
C
H
N
I
C
A

D
A
T
A





S
H
E
E
T

/

F
I
C
H
A

T
E
C
N
I
C
A





11 CARRITOS

Modelos <i>Models</i>	CARRITO BASE	CARRITO THERMAL
Dimensiones y Peso <i>Measures and Weight</i>	cm 61x42x95h. - 23 kg	cm 60x68x101h. - 48 kg
Material <i>Material</i>	Madera Okumé / <i>Massive okumé wood</i>	Madera Okumé / <i>Massive okumé wood</i>
Características <i>Features</i>	3 estantes, 1 cajón <i>3 shelves, 1 drawer</i>	Bañera de aluminio con termostato, 2 cubetas de cerámica, bandeja de soporte inferior <i>Aluminum basin with thermostat, 2 ceramic bowls with carved logo, lower shelf</i>
Opciones especiales <i>Special options</i>	X	X
Acabados disponibles / <i>Available finishings</i>	 okumè  wengé	 okumè  wengé



AVANTwell

12 COMPLEMENTOS

Modelos <i>Models</i>	LÁMPARA STERRY	PERCHERO
Dimensiones y Peso <i>Measures and Weight</i>	cm 220x120 - 31 kg	cm 67x55x160h. - 23 kg
Material <i>Material</i>	Madera Okumé / <i>Massive okumé wood</i>	Madera Okumé / <i>Massive okumé wood</i>
Características <i>Features</i>	Sistema de anclaje a techo, 150 puntos de luz de fibra óptica, mando a distancia con selector de ciclo de cromoterapia <i>Ceiling retaining system, 150 optical fibre lights, remote control for chromotherapy</i>	4 brazos para perchas de diferentes longitudes, base sólida de madera maciza con logo hexagonal tallado <i>4 robe holders of different lengths, strong massive wood stand with carved Esagono logo</i>
Opciones especiales <i>Special optional</i>	Disponibile también en forma rectangular <i>Available in rectangular shape</i>	X
Acabados disponibles / <i>Available finishings</i>	 	  okumè wengé



T
E
C
H
N
I
C
A

D
A
T
A

S
H
E
E
T

/

F
I
C
H
A

T
E
C
N
I
C
A

AVANTwell

EQUIPMENTS

